

4.479GHz LO

VCTCXO:12.8MHz VCO:2.2395GHz OUT:4.479GHz/≒2~6dB

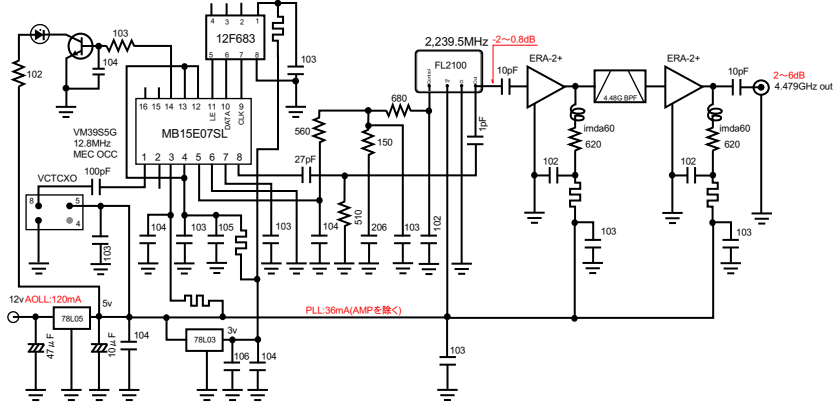

- DC9~15V: 赤 / + 黒 / -
- 一部表記に誤りの可能性があります。

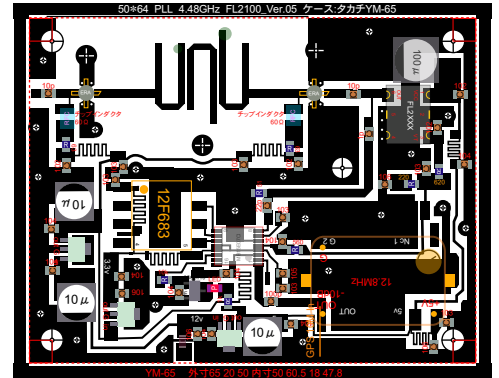

高精度 温度補償型水晶発振器 VCTCXO

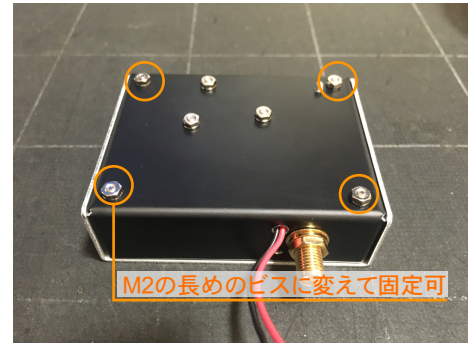
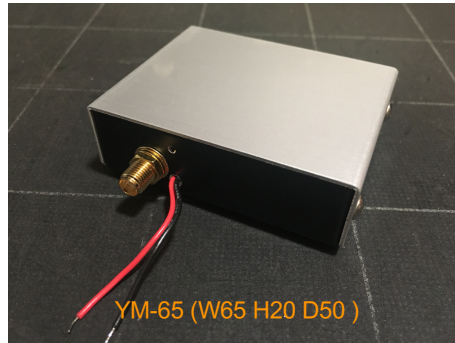
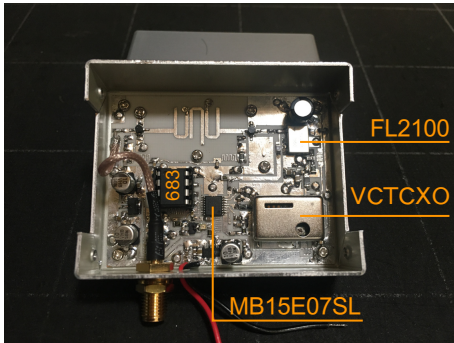

Center : 4.479GHz / Span : 1MHz

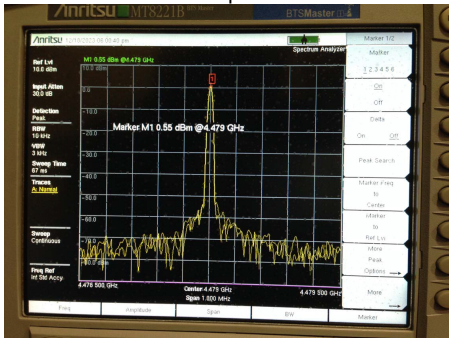

Center : 2.2395GHz / Span : 1MHz

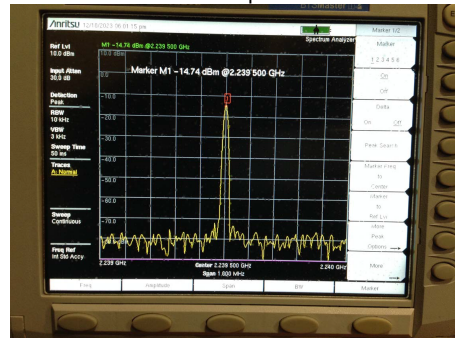

Center : 4.479GHz / Span : 5GHz

